

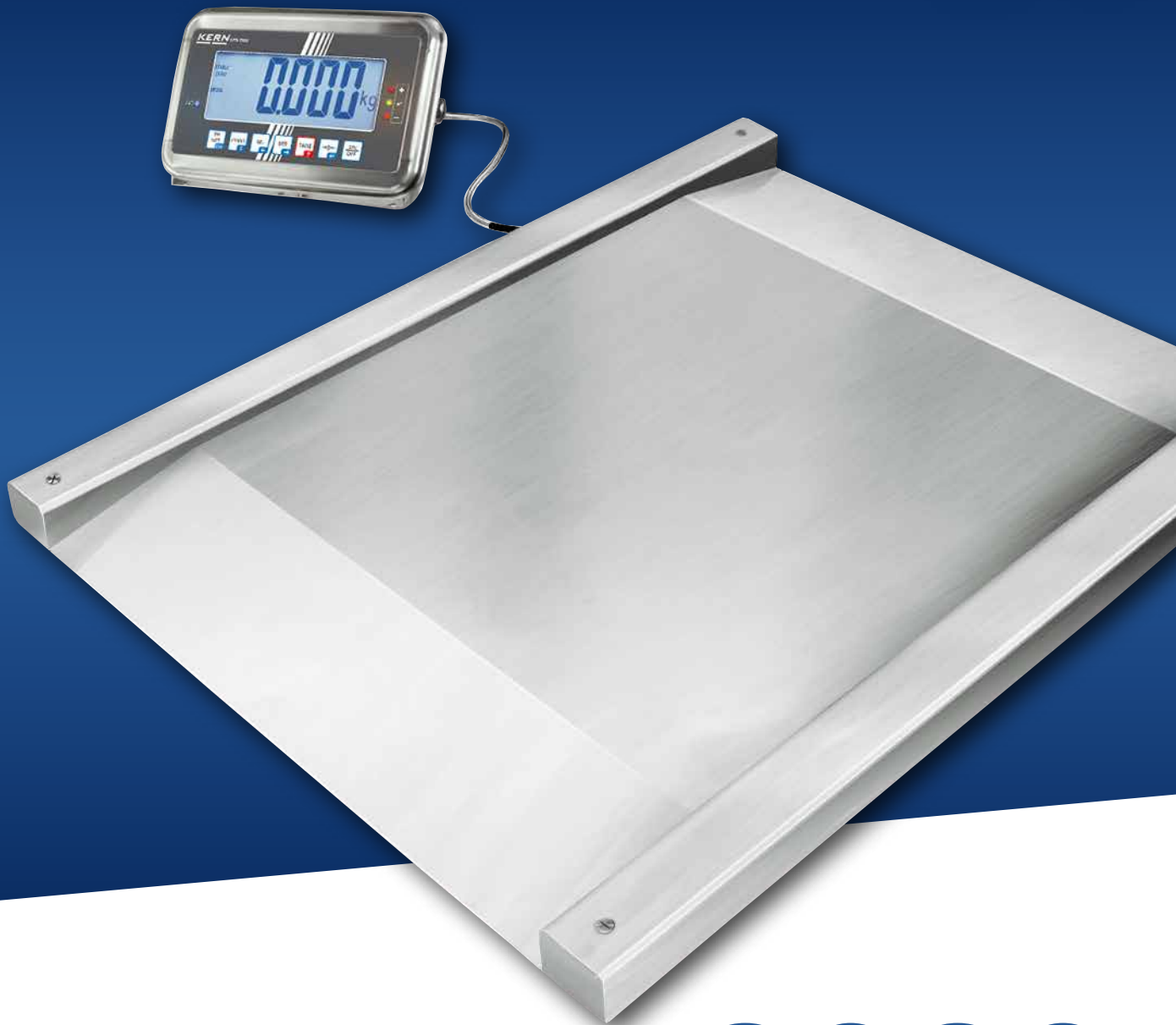







































FLOOR SCALES/PALLET SCALES/ DRIVE-THROUGH SCALES

PROFESSIONAL
MEASURING



2020

KERN Pictograms

 Internal adjusting: Quick setting up of the balance's accuracy with internal adjusting weight (motordriven)	 KERN Communication Protocol (KCP): It is a standardized interface command set for KERN balances and other instruments, which allows retrieving and controlling all relevant parameters and functions of the device. KERN devices featuring KCP are thus easily integrated with computers, industrial controllers and other digital systems	 Protection against dust and water splashes IPxx: The type of protection is shown in the pictogram. For details see page 62
 Adjusting program CAL: For quick setting up of the balance's accuracy. External adjusting weight required	 GLP/ISO log: The balance displays serial number, user ID, weight, date and time, regardless of a printer connection	 Stainless steel: The balance is protected against corrosion
 Easy Touch: Suitable for the connection, data transmission and control through PC, tablet or smartphone	 GLP/ISO log: With weight, date and time. Only with KERN printers, see page 171-173	 Suspended weighing: Load support with hook on the underside of the balance
 Memory: Balance memory capacity, e.g. for article data, weighing data, tare weights, PLU etc.	 Piece counting: Reference quantities selectable. Display can be switched from piece to weight	 Battery operation: Ready for battery operation. The battery type is specified for each device
 Alibi memory: Secure, electronic archiving of weighing results, complying with the 2014/31/EU standard. For details see page 223	 Recipe level A: The weights of the recipe ingredients can be added together and the total weight of the recipe can be printed out	 Rechargeable battery pack: Rechargeable set
 Data interface RS-232: To connect the balance to a printer, PC or network	 Recipe level B: Internal memory for complete recipes with name and target value of the recipe ingredients. User guidance through display	 Universal mains adapter: with universal input and optional input socket adapters for A) EU, CH, GB B) EU, CH, GB, USA C) EU, CH, GB, USA, AUS
 RS-485 data interface: To connect the balance to a printer, PC or other peripherals. Suitable for data transfer over large distances. Network in bus topology is possible	 Recipe level C: Internal memory for complete recipes with name and target value of the recipe ingredients. User guidance through display, multiplier function, adjustment of recipe when dosages are exceeded or barcode recognition	 Mains adapter: 230V/50Hz in standard version for EU, CH. On request GB, USA or AUS version available
 USB data interface: To connect the balance to a printer, PC or other peripherals	 Totalising level A: The weights of similar items can be added together and the total can be printed out	 Power supply: Integrated in balance. 230V/50Hz standard EU. More standards e.g. GB, USA or AUS on request
 Bluetooth* data interface: To transfer data from the balance to a printer, PC or other peripherals	 Percentage determination: Determining the deviation in % from the target value (100 %)	 Weighing principle: Strain gauges Electrical resistor on an elastic deforming body
 WLAN data interface: To transfer data from the balance to a printer, PC or other peripherals	 Weighing units: Can be switched to e.g. nonmetric units at the touch of a key. See balance model. Please refer to KERN's website for more details	 Weighing principle: Tuning fork A resonating body is electromagnetically excited, causing it to oscillate
 Control outputs (optocoupler, digital I/O): To connect relays, signal lamps, valves, etc.	 Weighing with tolerance range: (Checkweighing) Upper and lower limiting can be programmed individually, e.g. for sorting and dosing. The process is supported by an audible or visual signal, see the relevant model	 Weighing principle: Electromagnetic force compensation Coil inside a permanent magnet. For the most accurate weighings
 Analogue interface: to connect a suitable peripheral device for analogue processing of the measurements	 Hold function: (Animal weighing program) When the weighing conditions are unstable, a stable weight is calculated as an average value	 Weighing principle: Single cell technology: Advanced version of the force compensation principle with the highest level of precision
 Interface for second balance: For direct connection of a second balance	 Package shipment: The time required for internal shipping preparations is shown in days in the pictogram	 Verification possible: The time required for verification is specified in the pictogram
 Network interface: For connecting the scale to an Ethernet network	 Pallet shipment: The time required for internal shipping preparations is shown in days in the pictogram	 DAkkS calibration possible (DKD): The time required for DAkkS calibration is shown in days in the pictogram
 Wireless data transfer: between the weighing unit and the evaluation unit using an integrated radio module		

KERN – measuring technology and testing services from a single source



Balances & Test service catalogue

Provides a complete overview of the KERN line of balances, test weights, and services such as verification, calibration, etc.



Medical scales catalogue

Complete line of medical scales, from infant scales to patient scales, chair scales and adiposity scales, as well as hand grip dynamometers, chemist's balances and veterinary scales.



Microscopes & refractometers catalogue

Extensive range in the area of optical instruments, such as, for example, biological microscopes, stereo microscopes, metallurgical microscopes, polarisation microscopes as well as analogue and digital refractometers.



SAUTER measuring equipment catalogue

Test instruments for industry and commerce, such as force, coating thickness, material thickness and calibration service.



DAkkS calibration service brochure

Detailed information on topics pertaining to the calibration and verification of balances, test weights, and force measuring devices.

Your advantages

fast

- 24 hours delivery service for products in stock – ordered today, on its way tomorrow
- Sales & service hotline available from 8:00 am to 6:00 pm

reliable

- Up to 3 years warranty
- Precision in weighing technology for more than 175 years

competent

- DAkkS accreditation DIN EN ISO/IEC 17025
- Certified QM system DIN EN ISO 9001
- Authorisation for initial verification by the manufacturer 2014/31/EU
- Medical certifications DIN EN ISO 13485 and 93/42/EWG

versatile

- One-stop shopping: from pocket balances through to 15 t crane balance – everything from one supplier
- Find the product you want at lightning speed with the “Balance Quick-Finder” at www.kern-sohn.com



Order hotline
+49 7433 9933-0



Online Shop
www.kern-sohn.com



Service hotline
+49 7433 9933-199



E-mail order
info@kern-sohn.com



Calibration hotline
+49 7433 9933-196



Fax order
+49 7433 9933-146



Our team of consultants will assist you
from Monday to Friday
from 8:00 am to 6:00 pm



www.kern-sohn.com

Information on current product availability, product data sheets, user instructions, useful knowledge, technical glossary, images and much for you to download, practical topic areas, which will guide you to the right product in your industry as well as a clever test weight and balance search engine.

Floor scales/Pallet scales/Drive-through scales

Robust aid for weighing large loads

KERN offers a carefully coordinated range from affordable entry level models, to practical built-in solutions, up to the top level verified models made of stainless steel. Their common feature is the long-lasting industrial quality as well as the high level of protection against dust and spray.

The installation, startup, and possible verification of floor, pallet, and drive-through scales require specialised knowledge, which is the basis for a successful sale. Please ask for our "Floor scale info sheet".

High-capacity scales – ideal for piece counting with large item quantities

The weighing ranges of bench counting scales are often not sufficient to count large quantities, units, palletised items etc. This is where high-performance counting systems are employed as these combine a high-precision reference balance with a high-capacity bulk scale, such as e.g. floor scales, pallet scales or drive-through scales. Your personal KERN customer consultant will be happy to help you setting up the right high-capacity counting system.

Individuality is the trump card – we create your ideal scale!

Do you have any special requests, which are not covered by our extensive floor scale range? Then why not configure your ideal model yourself, it's quick, individual and affordable.

Of course we can also offer you the complete service and put the required scale combination together for you, including verification. All further details can be found from page 137 ff. or ask your personal customer service agent, he will be pleased to advise you



Florian Bächle

Product specialist Floor scales/
Pallet scales/Drive-through scales
Tel. +49 7433 9933-118
Fax +49 7433 9933-29118
florian.baechle@kern-sohn.com

from €
750,-

- ▷ High-resolution floor scale with 2 x 3000 [d]
- ▷ Massive steel weighing bridge with IP67 protection
- ▷ Optimised price performance ratio

Proof of compatibility
Conformity evaluation
Conformity declaration

HIGHLIGHT

Quick-Finder Floor scales/Pallet scales/Drive-through scales

Readability [d] g	Weighing capacity [Max] kg	Weighing plate W×D×H mm	Model KERN	Price excl. of VAT ex works €	Page											
						For an explanation on the pictos, see front flap										
100	300	1050×1050×100	MWB 300K-1	690,-	123	2			●						●	
100 200	300 600	1000×1000×108	BIC 600K-1S	750,-	115	2			●						●	
100 200	300 600	1200×1500×108	BIC 600K-1	990,-	115	2			●						●	
100 200	300 600	1000×1000×108	BID 600K-1DSM	1090,-	116	2	○		●	●	●				●	
100 200	300 600	1200×1500×108	BID 600K-1DM	1320,-	116	2	○		●	●	●				●	
100 200	300 600	1195×840×110	UID 600K-1DM	960,-	126	2	○		●	●	●	●			●	○
200	600	1000×1000×108	BID 600K-1SM	1020,-	116	2	○		●	●	●				●	
200	600	1200×1500×108	BID 600K-1M	1250,-	116	2	○		●	●	●				●	
200	600	1000×1000×85	BFB 600K-1SNM	1100,-	118	2	○		●	●	●				●	○
200	600	1500×1250×85	BFB 600K-1NM	1490,-	118	2	○		●	●	●				●	○
200	600	1000×1000×85	BFA 600K-1SNM	1160,-	120	2	○		●	○	●				●	○
200	600	1500×1250×85	BFA 600K-1NM	1580,-	120	2	○		●	○	●				●	○
200	600	1000×1000×80	BFN 600K-1SM	2450,-	121	2	○		●	○	●				●	○
200	600	1000×1000×80	BXS 600K-1SM	1490,-	122	2	○		●	○	●				●	○
200	600	1500×1250×80	BXS 600K-1M	1700,-	122	2	○		●	○	●				●	○
200	600	800×120×100	UFA 600K-1S	880,-	124	2			●	●	●				●	○
200	600	1195×840×110	UID 600K-1M	920,-	126	2	○		●	●	●	●			●	○
200	600	1190×840×90	UFB 600K200M	950,-	127	2	○		●	●	●				●	○
200	600	1195×840×110	UIB 600K-1	760,-	128	2			●	●	●				●	○
200	600	840×1300×90	UFN 600K200IPM	1290,-	129	2	○		●	○	●				●	○
200	600	1600×1200×80	NFB 600K200M	1450,-	130	2	○		●	●	●				●	○
200	600	1800×1400×80	NFB 600K200LM	1650,-	130	2	○		●	●	●				●	○
200	600	1600×1200×80	NFN 600K-1M	2750,-	131	2	○		●	○	●				●	○
200 500	600 1500	1000×1000×108	BIC 1T-4S	750,-	115	2			●						●	
200 500	600 1500	1200×1500×108	BIC 1T-4	990,-	115	2			●						●	
200 500	600 1500	1000×1000×108	BID 1T-4DSM	1090,-	116	2	○		●	●	●				●	
200 500	600 1500	1200×1500×108	BID 1T-4DM	1350,-	116	2	○		●	●	●				●	
200 500	600 1500	1195×840×110	UID 1500K-1DM	960,-	126	2	○		●	●	●	●			●	○
500	1500	1000×1000×108	BID 1T-4SM	1020,-	116	2	○		●	●	●				●	
500	1500	1200×1000×108	BID 1T-4EM	1120,-	116	2	○		●	●	●				●	
500	1500	1200×1500×108	BID 1T-4M	1280,-	116	2	○		●	●	●				●	
500	1500	1500×1500×108	BID 1T-4LM	1490,-	116	2	○		●	●	●				●	
500	1500	1000×1000×100	BFB 1T-4SNM	1100,-	118	2	○		●	●	●				●	○
500	1500	1500×1250×90	BFB 1T-4NM	1490,-	118	2	○		●	●	●				●	○
500	1500	1000×1000×95	BFA 1T-4SNM	1170,-	120	2	○		●	○	●				●	○
500	1500	1500×1250×85	BFA 1T-4NM	1580,-	120	2	○		●	○	●				●	○
500	1500	1000×1000×80	BFN 1T-4SM	2450,-	121	2	○		●	○	●				●	○
500	1500	1500×1250×80	BFN 1.5T0.5M	3050,-	121	2	○		●	○	●				●	○
500	1500	1000×1000×80	BXS 1.5T-4SM	1350,-	122	2	○		●	○	●				●	○
500	1500	1200×120×100	UFA 1.5T0.5	870,-	124	2			●	●	●				●	○
500	1500	1195×840×110	UID 1500K-1M	920,-	126	2	○		●	●	●	●			●	○
500	1500	1190×840×90	UFB 1.5T0.5M	950,-	127	2	○		●	●	●				●	○
500	1500	1195×840×110	UIB 1.5T-4	760,-	128	2			●	●	●				●	○
500	1500	840×1360×90	UFC 1T-1M	990,-	128	2	○		●	○	●				●	○
500	1500	840×1300×90	UFN 1.5T0.5IPM	1590,-	129	2	○		●	○	●				●	○
500	1500	1600×1200×80	NFB 1.5T0.5M	1350,-	130	2	○		●	●	●				●	○
500	1500	1800×1400×80	NFB 1.5T0.5LM	1650,-	130	2	○		●	●	●				●	○
500	1500	1600×1200×80	NFN 1.5T-4M	2980,-	131	2	○		●	○	●				●	○
500 1000	1500 3000	1200×1500×108	BIC 3T-3	990,-	115	2			●						●	
500 1000	1500 3000	1500×1500×108	BIC 3T-3L	1200,-	115	2			●						●	
500 1000	1500 3000	1200×1500×108	BID 3T-3DM	1360,-	116	2	○		●	●	●				●	
500 1000	1500 3000	1500×1500×108	BID 3T-3DLM	1520,-	116	2	○		●	●	●				●	
500 1000	1500 3000	1195×840×110	UID 3000K-0DM	960,-	126	2	○		●	●	●	●			●	○
1000	3000	1200×1500×108	BID 3T-3M	1290,-	116	2	○		●	●	●				●	
1000	3000	1500×1500×108	BID 3T-3LM	1470,-	116	2	○		●	●	●				●	
1000	3000	1500×1250×85	BFB 3T-3NM	1490,-	118	2	○		●	●	●				●	○
1000	3000	1500×1500×80	BFB 3T1LM	1700,-	118	2	○		●	●	●				●	○
1000	3000	1500×1250×85	BFA 3T-3NM	1580,-	120	2	○		●	○	●				●	○
1000	3000	1500×1500×85	BFA 3T-3LM	1780,-	120	2	○		●	○	●				●	○
1000	3000	1500×1250×80	BFN 3T-3M	3050,-	121	2	○		●	○	●				●	○
1000	3000	1500×1250×80	BXS 3T-3M	1700,-	122	2	○		●	○	●				●	○
1000	3000	1200×120×100	UFA 3T1	890,-	124	2			●	●	●				●	○
1000	3000	1200×120×100	UFA 3T-3L	1050,-	124	2			●	●	●				●	○
1000	3000	1195×840×110	UID 3000K-0M	920,-	126	2	○		●	●	●	●			●	○
1000	3000	1195×840×110	UIB 3T-3	760,-	128	2			●	●	●				●	○
2000	6000	1500×1500×130	BFB 6T-3M	1980,-	118	2	○		●	●	●				●	○
2000	6000	1500×1500×130	BFA 6T-3M	2040,-	120	2	○		●	○	●				●	○
2000	6000	1200×160×100	UFA 6T-3	1190,-	124	2			●	●	●				●	○
2000	6000	1200×160×100	UFA 6T-3L	1490,-	124	2			●	●	●				●	○



“

From goods receipt to production and shipping – KERN floor scales, pallet truck scales and crane scales can be used anywhere and are intuitive to use. With numerous clever functions they will help you to fulfil the increased demands of Industry 4.0 and carry out your processes in a more effective manner, with better use of resources.

”

*Florian Bächle,
Product Specialist Industrial scales*

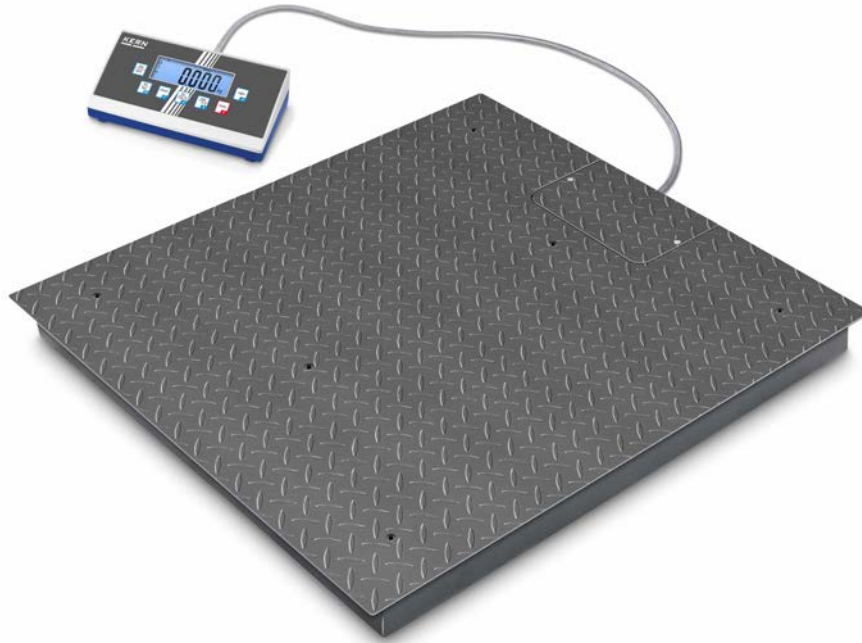

High resolution floor scale with 2×3000 [d] and the best price to performance ratio

Features

- **Weighing bridge:** out of anti-slip corrugated steel, 4 silicone-coated steel load cells, versatile supported, therefore especially shock absorbent, even against transverse forces, dust and spray protection IP67
- **Welded platform** with screw holes to lift the balance for easy cleaning
- **Easy levelling of the weighing bridge** as well as **access to the junction box** from above
- **Simple and convenient 4-key operation**
- **Wall mount** for display device, standard
- A clever **plug-in connector** means that you can easily separate the display device and the platform, e.g. for installing the balance in a packing and dispatch bench, pit frame etc. at a later date
- **Did you know?** Our floor scales are delivered in a robust wooden box. This protects the high-quality weighing technology from environmental influences and stresses during transportation. KERN – always one step ahead

Technical data

- Large LCD display, digit height 25 mm
- Weighing plate dimensions W×D×H
 - A** 1000×1000×108 mm
 - B** 1200×1500×108 mm
 - C** 1500×1500×108 mm
- Dimensions of display device W×D×H 235×114×51 mm
- Optional battery operation, 4×1.5 V AA not included in scope of delivery, operating time up to 60 h
- Cable length of display device approx. 5 m
- Permissible ambient temperature -10 °C/40 °C

Accessories

- **Protective working cover** over display device, delivery quantity: 5 items, KERN EOB-A02S05, **€ 40,-**
- **Pair of base plates** to fix the weighing bridge to the floor, KERN BIC-A07, **€ 40,-**
- **Ascending ramp**, steel, powder coated, not included, for models with weighing plate size
 - A** 1000×1000×108 mm, KERN BIC-A01, **€ 350,-**
 - B** 1200×1000×108 mm, KERN BIC-A02, **€ 380,-**
 - C** 1500×1000×108 mm, KERN BIC-A03, **€ 465,-**
- **Stable pit frame**, steel, powder coated, for models with weighing plate size
 - A** 1088×1088×110 mm, KERN BIC-A04, **€ 300,-**
 - B** 1288×1588×110 mm, KERN BIC-A05, **€ 335,-**
 - C** 1588×1588×110 mm, KERN BIC-A06, **€ 355,-**

STANDARD

CAL EXT UNIT IP 67 BATT MULTI DMS 2 DAYS

OPTION

DAKKS +3 DAYS

! Shipment via freight forwarder. Please ask for dimensions, gross weight, shipping costs

Model	Weighing capacity [Max] kg	Readability [d] kg	Net weight approx. kg	Weighing plate	Price excl. of VAT ex works €	Option	
						DAKKS KERN	DAKKS Calibr. Certificate €
Dual-range balance switches automatically to the next largest weighing capacity [Max] and readability [d]							
BIC 600K-1S	300 600	0,1 0,2	70	A	750,-	963-130	165,-
BIC 600K-1	300 600	0,1 0,2	150	B	990,-	963-130	165,-
BIC 1T-4S	600 1500	0,2 0,5	150	A	750,-	963-130	165,-
BIC 1T-4	600 1500	0,2 0,5	70	B	990,-	963-130	165,-
BIC 3T-3	1500 3000	0,5 1	150	B	990,-	963-132	440,-
BIC 3T-3L	1500 3000	0,5 1	150	C	1200,-	963-132	440,-

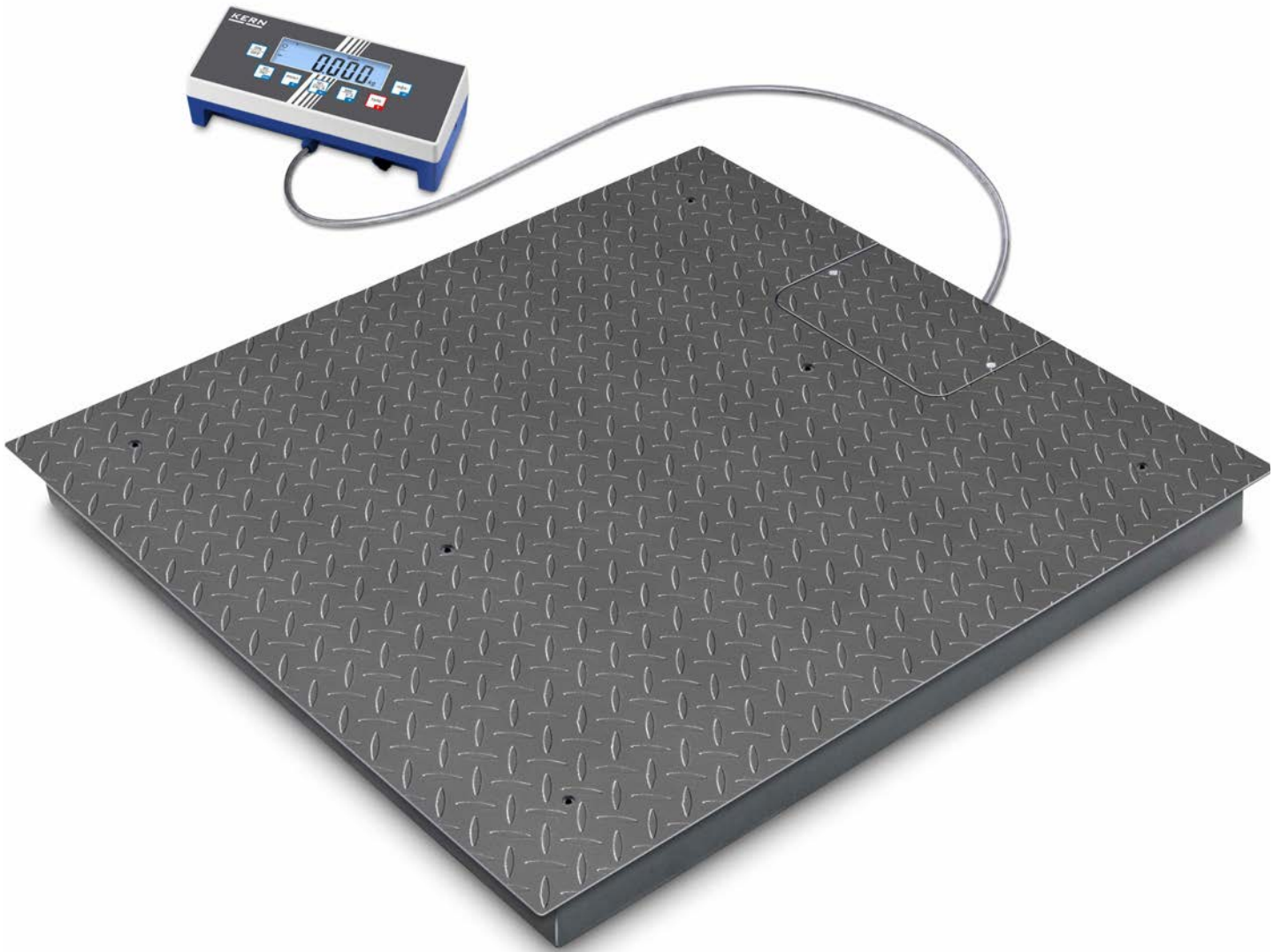

10

Floor scale with EC type approval [M]* and the best price-to-performance ratio – now also as a high-resolution dual-range scale



Did you know?

Our floor scales are delivered in a robust wooden box. This protects the high-quality weighing technology from environmental influences and stresses during transportation. KERN – always one step ahead



3 Access ramp incl. pair of base plates to facilitate access of e.g. wire cage trolleys, shelf trolleys, container trolleys, storage trolleys, sack trucks, transpallets, mobile containers, containers refuse etc.



4 Stable pit frame, to install the weighing bridge so you can drive straight on

Features

- **BID-D: Dual-range floor scales**, ideal, when high maximum loads need to be weighed, but in the lower load range you still need high resolution. This means that two balances can be replaced with one – which saves space and money!
- **BID 1T-4EM:** Compact special size, especially for weighing europallets
- **1 Weighing bridge:** out of anti-slip corrugated steel, 4 silicone-coated steel load cells, dust and spray protection IP67
- **Welded platform** with screw holes to lift the balance for easy cleaning
- **Easy levelling of the weighing bridge** as well as **access to the junction box** from above
- **2 Display device:** for details see KERN KIB-TM
- **Totalising** of weights and piece counts
- Thanks to **interfaces** such as RS-232 or USB, WiFi, Bluetooth, Ethernet (optional), the scale can easily be connected to existing networks. Data exchange between the scale, PC or printer
- **Searching and remote control of the balance** using external control devices or computers with the KERN Communication Protocol (KCP). KCP is a standardised interface command structure for KERN balances and other instruments which allows you to recall and manage all relevant parameters and device functions. You can therefore simply connect KERN devices with KCP to computers, industrial control systems and other digital systems. In a large number of cases the KCP is compatible with the MT-SICS protocol. Only possible through data interface RS-232, other interfaces on request

Technical data

- Large LCD display, digit height 25 mm
- Weighing plate dimensions WxDxH
 - A 1000x1000x108 mm
 - B 1200x1000x108 mm
 - C 1200x1500x108 mm
 - D 1500x1500x108 mm
- Dimensions of display device WxDxH 268x115x80 mm
- Cable length of display device approx. 5 m
- Permissible ambient temperature -10 °C/40 °C

Accessories

- **Protective working cover**, scope of delivery: 5 items, KERN EOC-A01S05, **€ 40,-**
- **Pair of base plates** to fix the weighing bridge to the floor, KERN BIC-A07, **€ 40,-**
- **3 Ascending ramp**, steel, powder coated, for models with weighing plate size
 - A, B KERN BIC-A01, **€ 350,-**
 - C KERN BIC-A02, **€ 380,-**
 - D KERN BIC-A03, **€ 465,-**
- **4 Stable pit frame**, steel, powder coated, to install the weighing bridge so you can drive straight on, for models with weighing plate size
 - A KERN BIC-A04, **€ 300,-**
 - B KERN BIC-A08, **€ 330,-**
 - C KERN BIC-A05, **€ 335,-**
 - D KERN BIC-A06, **€ 355,-**
- **Benchtop stand incl. wall mount** for display device, **Benchtop stand incl. wall mount** for display device, KERN EOC-A04, **€ 30,-**
- **Rechargeable battery pack internal**, operating time up to 43 h without backlight, charging time approx. 3 h, KERN KFB-A01, **€ 35,-**
- **USB data interface**, for transferring weighing to the PC, printer, not possible in combination with verification, KERN KIB-A03, **€ 120,-**

- **Bluetooth data interface** for wireless data transfer to PC or tablets, must be ordered at purchase, KERN KIB-A04, **€ 110,-**
- **WiFi interface** for wireless connection of the balance to networks and WiFi capable devices, such as tablets, laptops or smartphones, must be ordered at purchase, please ask for delivery time, KERN KIB-A10, **€ 55,-**
- **Ethernet data interface**, to connect an IP-based Ethernet network, must be ordered at purchase, not in combination with verification, KERN KIB-A02, **€ 150,-**
- **Signal lamp, including interface**, for visual support of weighing with tolerance range, Factory Option, KERN KIB-A06, **€ 320,-**
- **Alibi memory**, including USB interface for exporting weighing results to external data media such as USB sticks, hard disks, etc. Not in connection with calibration, KERN KIB-A01, **€ 95,-**
- **Verification plug**, for verified balances this enables you to separate the display device and platform without affecting the verification, e.g. for installing the scale in a packing and dispatch table, pit frame etc. at a later date. Please order this at the same time as you purchase your scale, KERN KIB-A12, **€ 80,-**

Note:

For verified scales the weighing bridge must be fixed to the floor. Optionally, with an access ramp, a footplate pair or a pit frame

In addition to the RS-232 data interface, which is integrated as standard, only one other data interface can be installed and operated

1 Shipment via freight forwarder. Please ask for dimensions, gross weight, shipping costs

STANDARD

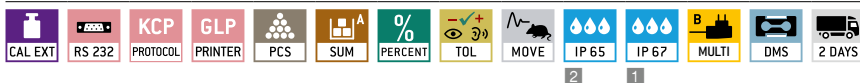

OPTION



FACTORY



Model	Weighing capacity [Max] kg	Readability = Verification value [d] = [e] kg	Minimal load [Min] kg	Net weight approx. kg	Weighing plate	Price excl. of VAT ex works €	Option			
							Verification		DAkKS Calibr. Certificate	
KERN						€	€	DAkKS KERN	€	
BID 600K-1SM	600	0,2	4	130	A	1020,-	965-230	132,-	963-130	165,-
BID 600K-1M	600	0,2	4	150	C	1250,-	965-230	132,-	963-130	165,-
BID 1T-4SM	1500	0,5	10	130	A	1020,-	965-230	132,-	963-130	165,-
BID 1T-4M	1500	0,5	10	75	C	1280,-	965-230	132,-	963-130	165,-
BID 1T-4EM	1500	0,5	10	65	B	1120,-	965-230	132,-	963-130	165,-
BID 1T-4LM	1500	0,5	10	80	D	1490,-	965-230	132,-	963-130	165,-
BID 3T-3M	3000	1	20	150	C	1290,-	965-232	200,-	963-132	440,-
BID 3T-3LM	3000	1	20	150	D	1470,-	965-232	200,-	963-132	440,-
Dual-range balance switches automatically to the next largest weighing capacity [Max] and readability [d]										
BID 600K-1DSM	300 600	0,1 0,2	4	130	A	1090,-	965-230	132,-	963-130	165,-
BID 600K-1DM	300 600	0,1 0,2	4	150	C	1320,-	965-230	132,-	963-130	165,-
BID 1T-4DSM	600 1500	0,2 0,5	10	130	A	1090,-	965-230	132,-	963-130	165,-
BID 1T-4DM	600 1500	0,2 0,5	10	150	C	1350,-	965-230	132,-	963-130	165,-
BID 3T-3DM	1500 3000	0,5 1	20	150	C	1360,-	965-232	200,-	963-132	440,-
BID 3T-3DLM	1500 3000	0,5 1	20	150	D	1520,-	965-232	200,-	963-132	440,-

Note: For applications that require verification, please order verification at the same time, initial verification at a later date is not possible. Verification at the factory, we need to know the full address of the location of use.

NEW New model

* Verification not in combination with KERN KIB-A02, KIB-A03, KIB-A04, KIB-A10



10

Weighing bridge with screwed-on weighing plate (IP67) and XXL display device, with EC type approval [M]



Weighing plate can be unscrewed
The weighing plate can be conveniently unscrewed for maintenance or cleaning purposes (weighing plate size **A**, **B**)



Easy levelling of the weighing bridge as well as access to the junction box from above



Did you know? Our floor scales are delivered in a robust wooden box. This protects the high-quality weighing technology from environmental influences and stresses during transportation. KERN – always one step ahead



Features

- **Weighing plate** **A**, **B** **screwed on from the top**, so it's easy to remove, hygienic and easy to clean
- **1 Weighing bridge**: steel, painted, weighing plate size **C**, **D** corrugated steel plate, welded, 4 silicone-coated steel load cells, dust and spray protection IP67
- **Display device**: for details see KERN KFB-TM
- **Benchtop stand incl. wall mount** for display device as standard
- **Totalising** of weights and piece counts
- **Protective working cover** included with delivery

Technical data

- Large backlit LCD display, digit height 52 mm
- Weighing plate dimensions WxDxH
 - A** 1000x1000x85 mm
 - B** 1500x1250x85 mm
 - C** 1500x1500x80 mm
 - D** 1500x1500x130 mm
- Dimensions of display device WxDxH 250x160x58 mm
- Cable length of display device approx. 5 m
- Permissible ambient temperature -10 °C/40 °C

Accessories

- **Protective working cover**, scope of delivery: 5 items, KERN KFB-A02S05, **€ 40,-**
- **2 Stand** to elevate display device, height of stand approx. 800 mm, KERN BFS-A07, **€ 120,-**
- **Pair of base plates** to fix the weighing bridge to the floor, for models with weighing plate size
 - A**, **B**, **C** KERN BFS-A06N, **€ 70,-**
 - D** KERN BFS-A10, **€ 60,-**
- **3 Ascending ramp**, steel, lacquered, not included, for models with weighing plate size
 - A** KERN BFS-A01N, **€ 310,-**
 - B** KERN BFS-A02N, **€ 350,-**
 - C** KERN BFS-A09N, **€ 460,-**
 - D** KERN BFS-A11, **€ 500,-**
- **4 Stable pit frame**, steel, lacquered, for models with weighing plate size
 - A** KERN BFS-A03N, **€ 310,-**
 - B** KERN BFS-A04N, **€ 370,-**
 - C** KERN BFS-A08, **€ 365,-**
- **Rechargeable battery pack internal**, operating time up to 35 h without backlight, charging time approx. 10 h, must be ordered at purchase, KERN KFB-A01, **€ 35,-**

- **Bluetooth data interface** for wireless data transfer to PC or tablets, must be ordered at purchase, not in combination with verification, not possible in combination with RS-232 data interface, KERN KFB-A03, **€ 130,-**
- **Analogue module**, must be ordered at purchase, not possible in combination with signal lamp 0-10 V: KERN KFB-A04, **€ 95,-**
4-20 mA: KERN KFB-A05, **€ 95,-**
- **Signal lamp** for visual support of weighing with tolerance range, KERN CFS-A03, **€ 250,-**
- **Large display with superior display size**, KERN YKD-A02, **€ 220,-**
- **Cable with special length** 15 m, between display device and platform, for verified models which must be ordered at the time of purchase, KERN BFB-A03, **€ 160,-**
- Further details, plenty of further accessories and suitable printers see *Accessories*

Note: For verified scales the weighing bridge must be fixed to the floor. Optionally, with an access ramp, a footplate pair or a pit frame

1 Shipment via freight forwarder. Please ask for dimensions, gross weight, shipping costs

STANDARD: CAL EXT, RS 232, KCP, PCS, SUM, TOL, MOVE, IP 67, MULTI, DMS, 2 DAYS

OPTION: DAKKS, BT 2.0, ANALOG, ACCU, +3 DAYS

FACTORY: M, +3 DAYS

Model	Weighing capacity [Max] kg	Readability = Verification value [d] = [e] kg	Minimal load [Min] kg	Net weight approx. kg	Weighing plate	Price excl. of VAT ex works €	Option			
							Verification		DAkkS Calibr. Certificate	
								€	DAkkS	€
BFB 600K-1SNM	600	0,2	4	105	A	1100,-	965-230	132,-	963-130	165,-
BFB 600K-1NM	600	0,2	4	135	B	1490,-	965-230	132,-	963-130	165,-
BFB 1T-4SNM	1500	0,5	10	100	A	1100,-	965-230	132,-	963-130	165,-
BFB 1T-4NM	1500	0,5	10	135	B	1490,-	965-230	132,-	963-130	165,-
BFB 3T-3NM	3000	1	20	135	B	1490,-	965-232	200,-	963-132	440,-
BFB 3T1LM	3000	1	20	155	C	1700,-	965-232	200,-	963-132	440,-
BFB 6T-3M	6000	2	40	210	D	1980,-	965-232	200,-	963-132	440,-

Note: For applications that require verification, please order verification at the same time, initial verification at a later date is not possible. Verification at the factory, we need to know the full address of the location of use.

Price reduction

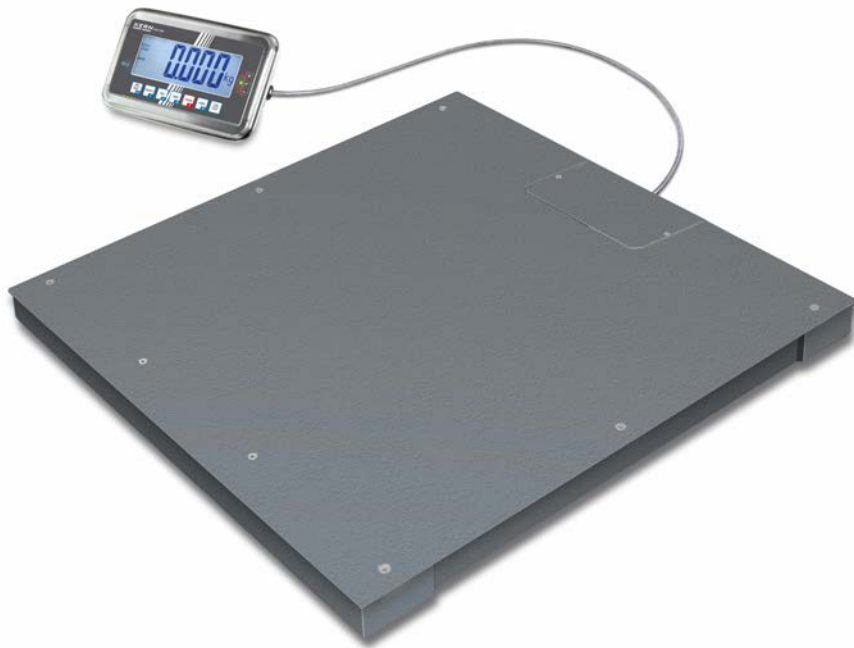

Weighing bridge with screwed-on weighing plate (IP67) and stainless steel display device (IP68), with EC type approval [M]

Features

- **Tough industry standard** suitable for use in harsh industrial applications
- **1 Weighing plate A, B screwed on from the top**, so it's easy to remove, hygienic and easy to clean
- **2 Weighing bridge:** steel, painted, weighing plate size C, D corrugated steel plate, welded, 4 silicone-coated steel load cells, dust and spray protection IP67. Weighing bridge can also be delivered as component without the display device, for details see KERN KFP-V20 IP67
- **Easy levelling of the weighing bridge** as well as **access to the junction box** from above
- **3 Display device:** stainless steel, protection against dust and water splashes IP65
- **Benchtop stand incl. wall mount** for display device as standard

Technical data

- Large backlit LCD display, digit height 52 mm
- Weighing plate dimensions W×D×H
 - A 1000×1000×85 mm
 - B 1500×1250×85 mm
 - C 1500×1500×80 mm
 - D 1500×1500×130 mm
- Dimensions of display device W×D×H 266×165×96 mm
- Cable length of display device approx. 5 m
- **Rechargeable battery pack internal**, operating time up to 35 h without backlight, charging time approx. 12 h
- Permissible ambient temperature -10 °C/40 °C

Accessories

- **4 Stand** to elevate display device, height of stand approx. 800 mm, KERN BFS-A07, € 120,-

- **Pair of base plates** to fix the weighing bridge to the floor, for models with weighing plate size
 - A, B, C KERN BFS-A06N, € 70,-
 - D KERN BFS-A10, € 60,-
- **Ascending ramp**, steel, lacquered, for models with weighing plate size
 - A KERN BFS-A01N, € 310,-
 - B KERN BFS-A02N, € 350,-
 - C KERN BFS-A09, € 410,-
 - D KERN BFS-A11, € 500,-
- **Stable pit frame**, steel, lacquered, for models with weighing plate size
 - A KERN BFS-A03N, € 310,-
 - B KERN BFS-A04N, € 370,-
 - C KERN BFS-A08, € 365,-
 - D KERN BFS-A12, € 650,-
- **Rechargeable battery pack internal**, operating time up to 35 h without backlight, charging time approx. 12 h, KERN GAB-A04, € 40,-
- **Data interface RS-232**, interface cable included, approx. 1,5 m, must be ordered at purchase, KERN KFN-A01, € 95,-
- **Large display with superior display size**, only in combination with data interface KFN-A1, KERN YKD-A02, € 220,-
- **Cable with special length** 15 m, between display device and platform, for verified models which must be ordered at the time of purchase, KERN BFB-A03, € 160,-
- Further details, plenty of further accessories and suitable printers see *Accessories*

Note: For verified scales the weighing bridge must be fixed to the floor. Optionally, with an access ramp, a footplate pair or a pit frame

! Shipment via freight forwarder. Please ask for dimensions, gross weight, shipping costs

STANDARD

CAL EXT | KCP | PCS | SUM | TOL | MOVE | IP 65 | IP 67 | INOX | ACCU | MULTI | DMS | 2 DAYS

OPTION | FACTORY

DAkKS +3 DAYS | RS 232 | BT 4.0 | M +3 DAYS

Model	Weighing capacity [Max] kg	Readability = Verification value [d] = [e] kg	Minimal load [Min] kg	Net weight approx. kg	Weighing plate	Price excl. of VAT ex works €	Option			
							Verification		DAkKS Calibr. Certificate	
							M III KERN	€	DAkKS KERN	€
BFA 600K-1SNM	600	0,2	4	105	A	1160,-	965-230	132,-	963-130	165,-
BFA 600K-1NM	600	0,2	4	135	B	1580,-	965-230	132,-	963-130	165,-
BFA 1T-4SNM	1500	0,5	10	100	A	1170,-	965-230	132,-	963-130	165,-
BFA 1T-4NM	1500	0,5	10	135	B	1580,-	965-230	132,-	963-130	165,-
BFA 3T-3NM	3000	1	20	135	B	1580,-	965-232	200,-	963-132	440,-
BFA 3T-3LM	3000	1	20	160	C	1800,-	965-232	200,-	963-132	440,-
BFA 6T-3M	6000	2	40	210	D	2040,-	965-232	200,-	963-132	440,-

Note: For applications that require verification, please order verification at the same time, initial verification at a later date is not possible. Verification at the factory, we need to know the full address of the location of use.

! ONLY WHILE STOCKS LAST



Stainless steel weighing bridge with screwed-on weighing plate (IP68) and stainless steel display device (IP65), with EC type approval [M]

Features

- **Tough industry standard** suitable for use in harsh industrial applications
- **Weighing plate screwed on from the top**, with stainless steel screws, so it's easy to remove, hygienic and easy to clean
- **1 Weighing bridge:** stainless steel, extremely resistant to bending due to material thickness, 4 welded stainless steel load cells, dust and spray protection IP68. Weighing bridge can also be delivered as component without the display device, for details see KERN KFP-V40
- Your support in a **HACCP-compliant** quality system
- **Easy levelling of the weighing bridge** as well as **access to the junction box** from above
- **2 Display device:** stainless steel, protection against dust and water splashes IP65, for industrial applications, hygienic and easy to clean, the display device can also be delivered as a component without the weighing bridge, for details see KERN KFN-TM
- **Benchtop stand incl. wall mount** for display device as standard
- **Totalising** of weights and piece counts

- **Rechargeable battery pack internal** included with delivery
- **3 Did you know?** Our floor scales are delivered in a robust wooden box. This protects the high-quality weighing technology from environmental influences and stresses during transportation. KERN – always one step ahead

Technical data

- Large backlit LCD display, digit height 52 mm
- Dimensions of display device W×D×H 266×165×96 mm
- Cable length of display device approx. 5 m
- Weighing plate dimensions W×D×H
 - A** 1000×1000×85 mm
 - B** 1500×1200×80 mm
- **Rechargeable battery pack internal**, operating time up to 35 h without backlight, charging time approx. 12 h
- Permissible ambient temperature -10 °C/40 °C

Accessories

- **4 Stand** to elevate display device, height of stand approx. 800 mm, KERN YKP-02, **€ 285,-**
- **Pair of base plates** to fix the weighing bridge to the floor, KERN BFN-A03, **€ 60,-**
- **5 Ascending ramp**, stainless steel, not included, for models with weighing plate size KERN BFN-A05, **€ 1090,-** KERN BFN-A01, **€ 1120,-**
- **6 Stable pit frame**, stainless steel, for models with weighing plate size KERN BFN-A06, **€ 730,-** KERN BFN-A02, **€ 850,-**
- **Data interface RS-232**, interface cable included, approx. 1,5 m, must be ordered at purchase, KERN KFN-A01, **€ 95,-**
- **Cable with special length** 15 m, between display device and platform, for verified models which must be ordered at the time of purchase, KERN BFB-A03, **€ 160,-**
- Further details, plenty of further accessories and suitable printers see *Accessories*

Note: For verified scales the weighing bridge must be fixed to the floor. Optionally, with an access ramp, a footplate pair or a pit frame

1 Shipment via freight forwarder. Please ask for dimensions, gross weight, shipping costs

STANDARD: CAL EXT, KCP, PCS, SUM, TOL, MOVE, IP 65, IP 68, INOX, ACCU, MULTI, DMS, 2 DAYS

OPTION: DAKKS +3 DAYS

FACTORY: RS 232 +3 DAYS

Model	Weighing capacity [Max] kg	Readability = Verification value [d] = [e] kg	Minimal load [Min] kg	Net weight approx. kg	Weighing plate	Price excl. of VAT ex works €	Option			
							Verification		DAkKS Calibr. Certificate	
KERN						M KERN	€	DAkKS KERN	€	
BFN 600K-1SM	600	0,2	4	100	A	2450,-	965-230	132,-	963-130	165,-
BFN 1T-4SM	1500	0,5	10	100	A	2450,-	965-230	132,-	963-130	165,-
BFN 1.5T0.5M	1500	0,5	10	135	B	3050,-	965-230	132,-	963-130	165,-
BFN 3T-3M	3000	1	20	135	B	3050,-	965-232	200,-	963-132	440,-

Note: For applications that require verification, please order verification at the same time, initial verification at a later date is not possible. Verification at the factory, we need to know the full address of the location of use.

1 ONLY WHILE STOCKS LAST **↓** Price reduction

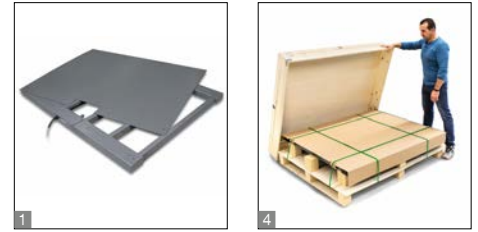

Weighing bridge with screwed-on weighing plate (IP67) and stainless steel display device (IP68), with EC type approval [M]

Features

- **Tough industry standard** suitable for use in harsh industrial applications
- **1 Weighing plate screwed on from the top**, so it's easy to remove, hygienic and easy to clean
- **2 Weighing bridge:** steel, painted, extremely resistant to bending due to material thickness, 4 silicone-coated steel load cells, dust and spray protection IP67.
- **Easy levelling of the weighing bridge** as well as **access to the junction box** from above
- **3 Display device:** stainless steel, protection against dust and water splashes IP68, for industrial applications, hygienic and easy to clean, integrated power supply
- **Benchtop stand incl. wall mount** for display device as standard
- **Totalising** of weights and piece counts
- Thanks to **interfaces** such as RS-232, RS-485 and Bluetooth (optional) the scale can easily be connected to existing networks and facilitates the data exchange between the scale and printer

- **4 Did you know?** Our floor scales are delivered in a robust wooden box. This protects the high-quality weighing technology from environmental influences and stresses during transportation. KERN – always one step ahead

Technical data

- Large backlit LCD display, digit height 55 mm
- Weighing plate dimensions, steel, painted W×D×H
 - A** 1000×1000×80 mm
 - B** 1500×1250×80 mm
- Dimensions of display device W×D×H 232×170×80 mm
- Cable length of display device approx. 5 m
- Permissible ambient temperature -10 °C/40 °C

Accessories

- **Stand** to elevate display device, height of stand approx. 750 mm, KERN YKP-02, **€ 190,-**
- **Pair of base plates** to fix the weighing bridge to the floor, KERN BXS-A03, **€ 70,-**

- **Ascending ramp**, steel, lacquered, for models with weighing plate size
 - A** KERN BXS-A01, **€ 350,-**
 - B** KERN BXS-A02, **€ 400,-**
- **Rechargeable battery pack internal**, operating time up to 80 h, without backlight, charging time approx. 12 h, KERN GAB-A04, **€ 40,-**
- **Data interface RS-232**, interface cable included, approx. 1,5 m, must be ordered at purchase, KERN KXS-A04, **€ 100,-**
- **Data interface RS-485**, must be ordered at purchase, KERN KXS-A01, **€ 145,-**
- **Bluetooth data interface** for wireless data transfer to PC or tablets, must be ordered at purchase, not in combination with verification, KERN KXS-A02, **€ 170,-**
- **Foot switch**, must be ordered at purchase, KERN KXS-A03, **€ 130,-**
- **Cable with special length** 15 m, between display device and platform, for verified models which must be ordered at the time of purchase, KERN BFB-A03, **€ 160,-**
- Further details, plenty of further accessories and suitable printers see *Accessories*

Note: For verified scales the weighing bridge must be fixed to the floor. Optionally, with an access ramp, a footplate pair or a pit frame

1 Shipment via freight forwarder. Please ask for dimensions, gross weight, shipping costs

STANDARD



OPTION



FACTORY

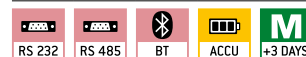

Model	Weighing capacity [Max] kg	Readability = Verification value [d] = [e] kg	Minimal load [Min] kg	Net weight approx. kg	Weighing plate	Price excl. of VAT ex works €	Option			
							Verification		DAkkS Calibr. Certificate	
KERN							M KERN	€	DAkkS KERN	€
BXS 600K-1SM	600	0,2	4	100	A	1490,-	965-230	132,-	963-130	165,-
BXS 600K-1M	600	0,2	4	145	B	1700,-	965-230	132,-	963-130	165,-
BXS 1.5T-4SM	1500	0,5	10	100	A	1350,-	965-230	132,-	963-130	165,-
BXS 3T-3M	3000	1	20	145	B	1700,-	965-232	200,-	963-132	440,-

Note: For applications that require verification, please order verification at the same time, initial verification at a later date is not possible. Verification at the factory, we need to know the full address of the location of use.

1 ONLY WHILE STOCKS LAST

Drive-through scale KERN MWB



Compact and robust drive-through scale (IP65) – particularly mobile thanks to handle, castors and low dead weight

Features

- Drive-through scale for rapid weighing of e.g. wire cage trolleys, shelf trolleys, container trolleys, storage trolleys, sack trucks, mobile containers, containers refuse etc.
- **1 Weighing bridge:** steel, lacquered, 4 silicone-coated aluminium load cells, protection against dust and water splashes IP65
- Secure and non-slip positioning with height-adjustable rubber feet
- **2** Level indicator to level the balance precisely
- **3** The scale can be easily transported using the two handles and two rollers and does not require much storage space
- **Hold function:** When the weighing conditions are unstable, a stable weight is calculated determining an average value
- **Wall mount for the display device,** as standard
- **Protective working cover** included with delivery

Technical data

- Large backlit LCD display, digit height 25 mm
- Overall dimensions, W×D×H 1050×1050×100 mm
- Platform height in the drive-through area: 50 mm
- Dimensions weighing surface W×D 800×800 mm
- Dimensions of display device W×D×H 200×130×60 mm
- Cable length of display device approx. 3 m
- Batteries included, 6×1,5 V AA, operating time up to 40 h
- Net weight approx. 55 kg

Accessories

- Protective working cover over the display device, scope of delivery: 5 items, KERN MBC-A06S05, € 40,-

STANDARD					OPTION	
CAL EXT	IP 65	BATT	DMS	2 DAYS	DAkkS	+3 DAYS

Model	Weighing capacity [Max] kg	Readability [d] kg	Price excl. of VAT ex works €	Option DAkkS Calibr. Certificate	
				DAkkS KERN	€
MWB 300K-1	300	0,1	690,-	963-129	105,-



Highly versatile weighing beams (IP67) for large loads to 6 t

Features

- Flexible solution for weighing large, bulky or long items
- **High mobility:** thanks to rechargeable battery operation (optional), compact, lightweight construction, it is suitable for the use in several locations
- **1 Weighing beams:** steel, lacquered, 4 silicone-coated aluminium load cells, protection against dust and water splashes IP67, Weighing beams can also be delivered as components without the display device, for details see KERN KFA-V20
- **Sturdy handles** for transporting the weighing beams
- **2** KERN UFA-L: Each weighing beam has a roller and handle for easy transport of the scale
- **Display device:** for details see KERN KFB-TM
- **Benchtop stand incl. wall mount** for display device as standard
- **Totalising** of weights and piece counts
- **Protective working cover** included with delivery

- KERN UFA-S: model with short weighing beams, ideal for weighing compact items or animals in transport boxes
- Did you know? Our floor scales are delivered in a robust wooden box. This protects the high-quality weighing technology from environmental influences and stresses during transportation. KERN – always one step ahead

Technical data

- Large backlit LCD display, digit height 52 mm
- Dimensions of display device W×D×H 250×160×65 mm
- Cable length of display device approx. 5 m
- Cable length weighing beams approx. 5 m
- Permissible ambient temperature -10 °C/40 °C

Accessories

- **Protective working cover**, scope of delivery: 5 items, KERN KFB-A02S05, € 40,-

- **3 Stand** to elevate display device, height of stand approx. 800 mm, KERN BFS-A07, € 120,-
- **Rechargeable battery pack internal**, operating time up to 35 h without backlight, charging time approx. 10 h, KERN KFB-A01, € 35,-
- **Bluetooth data interface** for wireless data transfer to PC or tablets, must be ordered at purchase, not in combination with verification, KERN KFB-A03, € 130,-
- Analogue module, must be ordered at purchase, not possible in combination with signal lamp
0-10 V: KERN KFB-A04, € 95,-
4-20 mA: KERN KFB-A05, € 95,-
- **4 Signal lamp** for visual support of weighing with tolerance range, not possible in combination with analogue module, KERN CFS-A03, € 250,-
- **5 Large display with superior display size**, KERN YKD-A02, € 220,-
- **Y-cable** for parallel connection of two terminal devices to the RS-232 interface on the scale, e.g. signal lamp and printer, KERN CFS-A04, € 35,-
- **Cable with special length** 15 m, between display device and platform, for verified models which must be ordered at the time of purchase, KERN BFB-A03, € 160,-
- Further details, plenty of further accessories and suitable printers see *Accessories*

1 Shipment via freight forwarder. Please ask for dimensions, gross weight, shipping costs

STANDARD



OPTION



FACTORY



Model	Weighing capacity [Max] kg	Readability [d] kg	Net weight approx. kg	Dimensions Weighing beam W×D×H mm	Price excl. of VAT ex works €	Option	
						DAkKS KERN	Calibr. Certificate €
KERN UFA 600K-1S	600	0,2	36	800×120×85	880,-	963-130	165,-
UFA 1.5T0.5	1500	0,5	38	1200×120×100	870,-	963-130	165,-
UFA 3T1	3000	1	38	1200×120×100	890,-	963-132	440,-
UFA 3T-3L	3000	1	60	2000×160×100	1050,-	963-132	440,-
UFA 6T-3	6000	2	85	1200×160×100	1190,-	963-132	440,-
UFA 6T-3L	6000	2	135	2000×160×100	1490,-	963-132	440,-

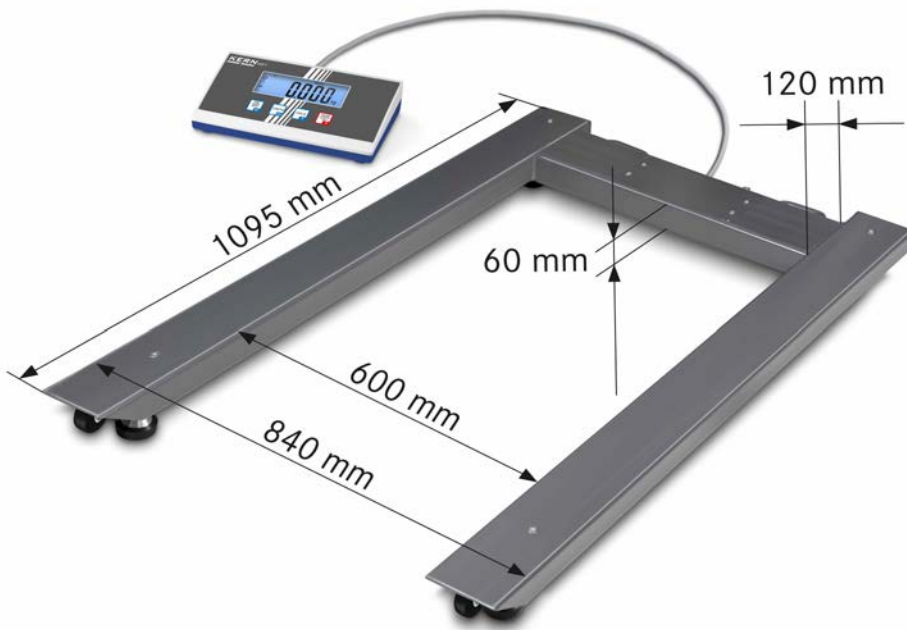

Pallet scale with steel load support (IP67) and the best price-to-performance ratio

Features

- **High mobility:** thanks to battery operation, compact, lightweight construction, it is suitable for the use in several locations
- **1 Load support:** steel, powder coated, 4 silicone-coated aluminium load cells, protection against dust and water splashes IP67
- **2** The scale can be easily transported using **rollers** and a **handle** and does not require much storage space
- **Totalising** of weights and piece counts
- **Protective working cover** included with delivery
- **3** Did you know? Our floor scales are delivered in a robust wooden box. This protects the high-quality weighing technology from environmental influences and stresses during transportation. KERN – always one step ahead

Technical data

- Large LCD display, digit height 25 mm
- Dimensions of display device W×D×H 235×115×52 mm
- Overall height including adjustable feet 110 mm
- Cable length of display device approx. 5 m
- Optional battery operation, 4×1.5 V AA not included in scope of delivery, operating time up to 60 h
- Net weight approx. 55 kg
- Permissible ambient temperature -10 °C/40 °C

Accessories

- **Protective working cover** over the display device, scope of delivery: 5 items, KERN EOB-A04BS05, **€ 40,-**
- **Stand** to elevate display device, height of stand approx. 1000 mm, KERN EOB-A02B, **€ 80,-**

1 Shipment via freight forwarder. Please ask for dimensions, gross weight, shipping costs

STANDARD

CAL EXT UNIT MOVE IP 67 BATT MULTI DMS 2 DAYS

OPTION

DAkKS +3 DAYS

Model	Weighing capacity [Max] kg	Readability [d] kg	Net weight approx. kg	Price excl. of VAT ex works €	Option	
					DAkKS KERN	DAkKS Calibr. Certificate €
KERN UIB 600K-1	600	0,2	55	760,-	963-130	165,-
UIB 1.5T-4	1500	0,5	55	760,-	963-130	165,-
UIB 3T-3	3000	1	55	760,-	963-132	440,-



- Cable length of display device approx. 5 m
- Net weight approx. 55 kg
- Permissible ambient temperature -10 °C/40 °C

Accessories

- **Protective working cover**, scope of delivery: 5 items, KERN EOC-A01S05, **€ 40,-**
- **Rechargeable battery pack internal**, operating time up to 43 h without backlight, charging time approx. 3 h, KERN KFB-A01, **€ 35,-**
- **USB data interface**, for transferring weighing to the PC, printer, not possible in combination with verification, KERN KIB-A03, **€ 120,-**
- **Bluetooth data interface** for wireless data transfer to PC or tablets, must be ordered at purchase, not in combination with verification, KERN KIB-A04, **€ 110,-**
- **WiFi interface** for wireless connection of the balance to networks and WiFi capable devices, such as tablets, laptops or smartphones, must be ordered at purchase, KERN KIB-A10, **€ 55,-**
- **Ethernet data interface**, to connect an IP-based Ethernet network, must be ordered at purchase, KERN KIB-A02, **€ 150,-**
- **Signal lamp, including interface**, for visual support of weighing with tolerance range, must be ordered at purchase, Factory Option, KERN KIB-A06, **€ 320,-**
- **Alibi memory**, including USB interface for exporting weighing results to external data media such as USB sticks, hard disks, etc. Not in connection with calibration, KERN KIB-A01, **€ 95,-**
- Further details, plenty of further accessories and suitable printers see *Accessories*

High resolution dual-range pallet scale with EC type approval [M] and a wide range of data interfaces

Features

- **NEW:** Dual-range floor scales, ideal when high maximum loads need to be weighed, but in the lower load range you still need high resolution. This means that two balances can be replaced with one – which saves space and money!
- **High mobility** thanks to battery operation for display device and platform
- **Load support:** steel, powder coated, 4 silicone-coated aluminium load cells, protection against dust and water splashes IP67
- The scale can be easily transported using **rollers** and a **handle** and does not require much storage space
- Thanks to **interfaces** such as RS-232 or USB, WiFi, Bluetooth, Ethernet (optional), the scale can easily be connected to existing networks. Data exchange between the scale, PC or printer

- **Searching and remote control of the balance** using external control devices or computers with the KERN Communication Protocol (KCP). KCP is a standardised interface command structure for KERN balances and other instruments which allows you to recall and manage all relevant parameters and device functions. You can therefore simply connect KERN devices with KCP to computers, industrial control systems and other digital systems. In a large number of cases the KCP is compatible with the MT-SICS protocol. Only possible through data interface RS-232, other interfaces on request
- **Protective working cover** included with delivery

Technical data

- Large backlit LCD display, digit height 25 mm
- Dimensions of display device WxDxH 268x115x80 mm
- Overall height including adjustable feet 110 mm

Note: In addition to the RS-232 interface, which is integrated as standard, only one other interface can be installed and operated

Shipment via freight forwarder. Please ask for dimensions, gross weight, shipping costs

STANDARD: CAL EXT, RS 232, KCP PROTOCOL, PCS, SUM, TOL, MOVE, IP 67, MULTI, DMS, 2 DAYS

OPTION: ACCU, DAKKS +3 DAYS

FACTORY: ALIBI, USB, BT 4.0, WLAN, LAN, M +3 DAYS

Model	Weighing capacity [Max] kg	Readability = Verification value [d] = [e] kg	Price excl. of VAT ex works €	Option			
				Verification		DAkkS Calibr. Certificate	
KERN					€	DAkkS	€
UID 600K-1M	600	0,2	920,-	965-230	132,-	963-130	165,-
UID 1500K-1M	1500	0,5	920,-	965-230	132,-	963-130	165,-
UID 3000K-0M	3000	1	920,-	965-232	200,-	963-132	440,-
Dual-range balance switches automatically to the next largest weighing capacity [Max] and readability [d]							
UID 600K-1DM	300 600	0,1 0,2	960,-	965-230	132,-	963-130	165,-
UID 1500K-1DM	600 1500	0,2 0,5	960,-	965-230	132,-	963-130	165,-
UID 3000K-0DM	1500 3000	0,5 1	960,-	965-232	200,-	963-132	440,-

Note: For applications that require verification, please order verification at the same time, initial verification at a later date is not possible. Verification at the factory, we need to know the full address of the location of use.

* Verification not in combination with KERN KIB-A02, KIB-A03, KIB-A04, KIB-A10

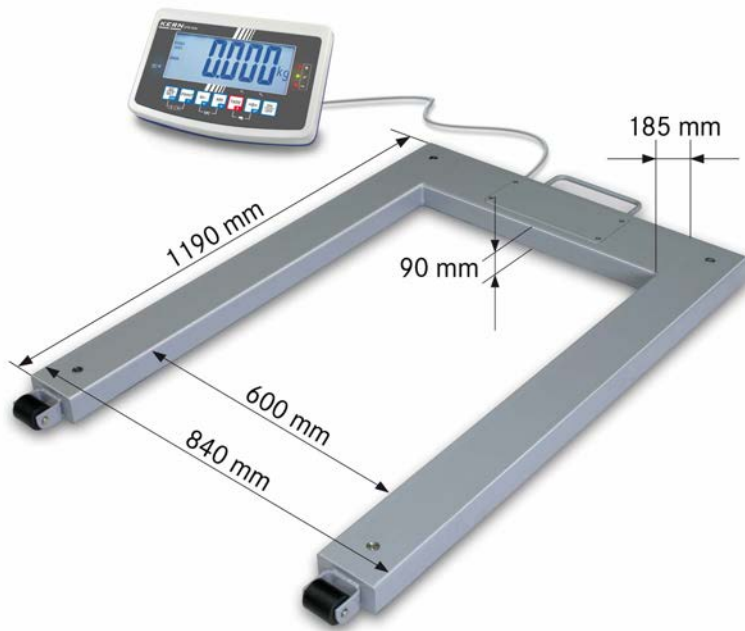

Pallet scale with steel load support (IP67) and EC type approval [M]

Features

- **High mobility:** thanks to rechargeable battery operation (optional), compact, lightweight construction, it is suitable for the use in several locations
- **1 Load support:** steel, powder coated, 4 silicone-coated aluminium load cells, protection against dust and water splashes IP67, Weighing bridge can also be delivered as component without the display device, for details see KERN KFU-V20
- Low height of the load fork, ideal for low pallets
- Two wheels for easy transportation of the scale
- **Weighing with tolerance range (check-weighing):** A visual and audible signal assists the rapid checking of items on pallets
- **Totalising** of weights and piece counts
- **Protective working cover** included with delivery
- **2 Did you know?** Our floor scales are delivered in a robust wooden box. This protects the high-quality weighing technology from environmental influences and stresses during transportation. KERN – always one step ahead

Technical data

- Large backlit LCD display, digit height 52 mm
- Dimensions of display device W×D×H 250×160×58 mm
- Overall height including adjustable feet 90 mm
- Cable length of display device approx. 5 m
- Net weight approx. 55 kg
- Permissible ambient temperature -10 °C/40 °C

Accessories

- **Protective working cover**, scope of delivery: 5 items, KERN KFB-A02S05, € 40,-
- **3 Stand** to elevate display device, height of stand approx. 800 mm, **Stand** to elevate display device, height of stand approx. 800 mm, KERN BFS-A07, € 120,-
- **Rechargeable battery pack internal**, operating time up to 35 h without backlight, charging time approx. 12 h, KERN KFB-A01, € 35,-
- **Bluetooth data interface** for wireless data transfer to PC or tablets, must be ordered at purchase, not in combination with verification, KERN KFB-A03, € 130,-

- **Analogue module**, must be ordered at purchase, not possible in combination with signal lamp
0-10 V: KERN KFB-A04, € 95,-
4-20 mA: KERN KFB-A05, € 95,-
- **4 Signal lamp** for visual support of weighing with tolerance range, KERN CFS-A03, € 250,-
- **5 Large display with superior display size**, KERN YKD-A02, € 220,-
- **Y-cable** for parallel connection of two terminal devices to the RS-232 interface on the scale, e.g. signal lamp and printer, KERN CFS-A04, € 35,-
- **Cable with special length** 15 m, between display device and platform, for verified models which must be ordered at the time of purchase, KERN BFB-A03, € 160,-
- Further details, plenty of further accessories and suitable printers see *Accessories*

1 Shipment via freight forwarder. Please ask for dimensions, gross weight, shipping costs

STANDARD

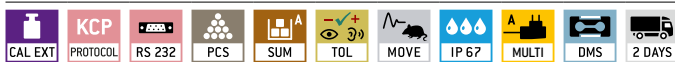

OPTION



FACTORY



Model	Weighing capacity [Max] kg	Readability [d] kg	Minimal load [Min] kg	Price excl. of VAT ex works €	Option			
					Verification		DAkkS Calibr. Certificate	
KERN							DAkkS	
					KERN	€	KERN	€
UFB 600K200M	600	0,2	4	950,-	965-230	132,-	963-130	165,-
UFB 1.5T0.5M	1500	0,5	10	950,-	965-230	132,-	963-130	165,-

Note: For applications that require verification, please order verification at the same time, initial verification at a later date is not possible. Verification at the factory, we need to know the full address of the location of use.

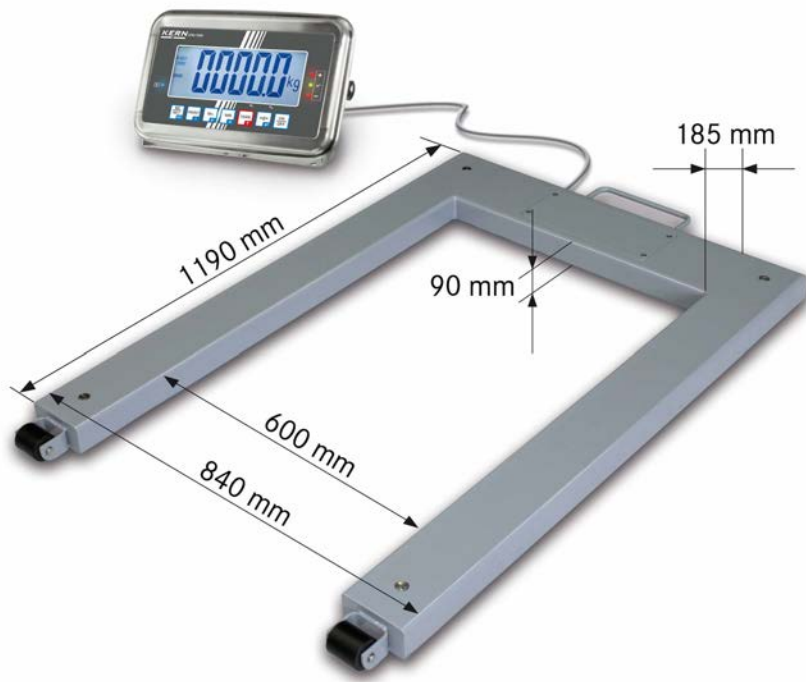

Pallet scale with steel load support (IP67) and stainless steel display device (IP65), with EC type approval [M]

Features

- **High mobility:** thanks to rechargeable battery operation (optional), compact, lightweight construction, it is suitable for the use in several locations
- **1 Load support:** steel, powder coated, 4 silicone-coated aluminium load cells, protection against dust and water splashes IP67, Weighing bridge can also be delivered as component without the display device, for details see KERN KFU V20
- Two wheels for easy transportation of the scale
- **2 Display device:** for details see KERN KFN-TM
- **Weighing with tolerance range (check-weighing):** A visual and audible signal assists the rapid checking of items on palettes
- **Totalising** of weights and piece counts
- **Rechargeable battery pack internal** included with delivery
- **3 Did you know?** Our floor scales are delivered in a robust wooden box. This protects the high-quality weighing technology from environmental influences and stresses during transportation. KERN – always one step ahead

Technical data

- Large backlit LCD display, digit height 52 mm
- Dimensions of display device WxDxH 266x165x96 mm
- Cable length of display device approx. 5 m
- Net weight approx. 55 kg
- Permissible ambient temperature -10 °C/40 °C

Accessories

- **4 Stand** to elevate display device, height of stand approx. 800 mm, KERN BFS-A07, € 120,-
- **Rechargeable battery pack internal**, operating time up to 35 h without backlight, charging time approx. 12 h, KERN GAB-A04, € 40,-
- **Data interface RS-232**, interface cable included, approx. 1,5 m, KERN KFN-A01, € 95,-
- **5 Signal lamp** for visual support of weighing with tolerance range, only in combination with data interface KFN-A1, KERN CFS-A03, € 250,-
- **6 Large display with superior display size**, only in combination with data interface KFN-A1, KERN YKD-A02, € 220,-
- **Cable with special length** 15 m, between display device and platform, for verified models which must be ordered at the time of purchase, KERN BFB-A03, € 160,-
- **Suitable printers** see *Accessories*

! Shipment via freight forwarder. Please ask for dimensions, gross weight, shipping costs

STANDARD



OPTION



FACTORY

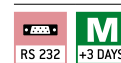

Model	Weighing capacity [Max] kg	Readability = Verification value [d] = [e] kg	Minimal load [Min] kg	Price excl. of VAT ex works €	Option			
					Verification		DAkkS Calibr. Certificate	
KERN					M III	€	DAkkS	€
UFC 1T-1M	1500	0,5	10	990,-	965-230	132,-	963-130	165,-

Note: For applications that require verification, please order verification at the same time, initial verification at a later date is not possible. Verification at the factory, we need to know the full address of the location of use.

! ONLY WHILE STOCKS LAST!

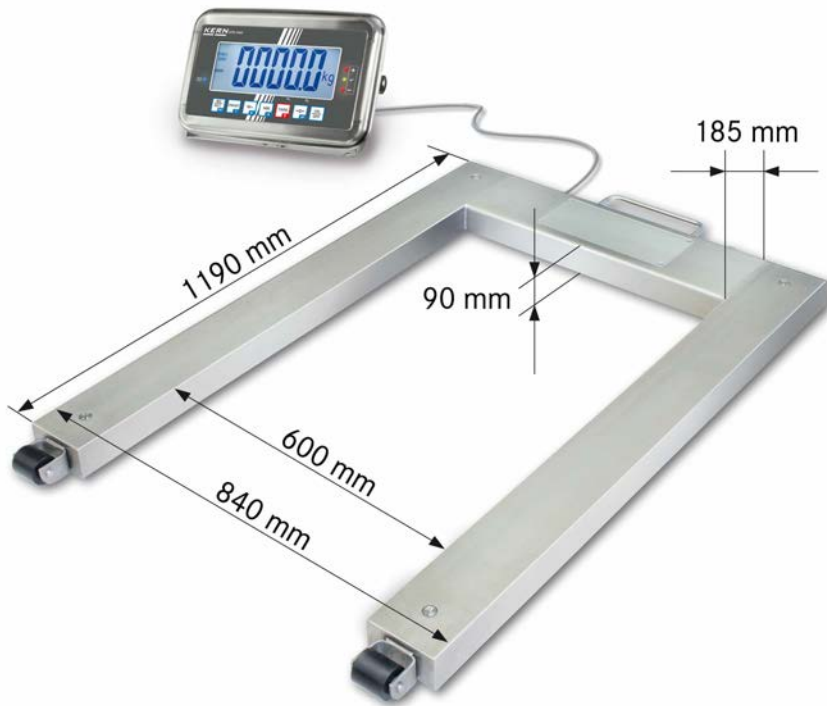

Pallet scale with stainless steel load support (IP67) and stainless steel display device (IP65), with EC type approval [M]

Features

- **High mobility:** thanks to rechargeable battery operation, compact, lightweight construction, it is suitable for the use in several locations (production, warehouse, dispatch department etc.)
- **1 Load support:** stainless steel, extremely resistant to bending due to material thickness, 4 silicone-coated stainless steel load cells, protection against dust and water splashes IP67, weighing bridge can also be delivered as component without the display device, for details see KERN KFU-V30
- Your support in a **HACCP**-compliant quality system
- **Suitable for the ever-increasing hygienic requirements** in the food industry
- **2 Display device:** for details see KERN KFN-TM
- The scale can be easily transported using **rollers** and a **handle** and does not require much storage space
- **Hold function:** When the weighing conditions are unstable, a stable weight is calculated determining an average value

Weighing with tolerance range (check-weighing): A visual and audible signal assists the rapid checking of items on pallets

- **Totalising** of weights
- **Rechargeable battery pack internal** included with delivery
- **3 Did you know?** Our floor scales are delivered in a robust wooden box. This protects the high-quality weighing technology from environmental influences and stresses during transportation. KERN – always one step ahead

Technical data

- Large backlit LCD display, digit height 52 mm
- Dimensions of display device WxDxH 266x165x96 mm
- Cable length of display device approx. 5 m
- Net weight approx. 55 kg
- Permissible ambient temperature -10 °C/40 °C

Accessories

- **4 Stand** to elevate display device, height of stand approx. 800 mm, KERN BFN-A04, € 285,-
- **Rechargeable battery pack internal**, operating time up to 35 h without backlight, charging time approx. 10 h, KERN GAB-A04, € 40,-
- **Data interface RS-232**, interface cable included, approx. 1,5 m, must be ordered at purchase, KERN KFN-A01, € 95,-
- **5 Large display with superior display size**, only in combination with data interface KFN-A1, KERN YKD-A02, € 220,-
- **Cable with special length** 15 m, between display device and platform, for verified models which must be ordered at the time of purchase, KERN BFB-A03, € 160,-
- Further details, plenty of further accessories and suitable printers see *Accessories*

Limited tare range with verifiable models 1/6 from [Max]

1 Shipment via freight forwarder. Please ask for dimensions, gross weight, shipping costs

STANDARD										OPTION		FACTORY	
				2	1								

Model	Weighing capacity [Max] kg	Readability = Verification value [d] = [e] kg	Minimal load [Min] kg	Price excl. of VAT ex works €	Option			
					Verification		DAkKS Calibr. Certificate	
KERN						€	DAkKS KERN	€
UFN 600K200IPM	600	0,2	4	1290,-	965-230	132,-	963-130	165,-
UFN 1.5T0.5IPM	1500	0,5	10	1590,-	965-230	132,-	963-130	165,-

Note: For applications that require verification, please order verification at the same time, initial verification at a later date is not possible. Verification at the factory, we need to know the full address of the location of use.

Price reduction



Drive-through scale (IP67) with XXL display device and EC type approval [M]

Features

- Drive-through scale for rapid weighing of e.g. wire cage trolleys, shelf trolleys, container trolleys, storage trolleys, sack trucks, transpallets, mobile containers, containers refuse etc.
- **Low platform height** and integrated access ramps on both sides facilitate access. No need for pit frame installation – which saves money
- **1 Weighing bridge:** out of anti-slip corrugated steel, 4 silicone-coated steel load cells, dust and spray protection IP67
- **Display device:** for details see KERN KFB-TM
- **Protective working cover** included with delivery
- **2** Did you know? Our floor scales are delivered in a robust wooden box. This protects the high-quality weighing technology from environmental influences and stresses during transportation. KERN – always one step ahead

Technical data

- Large backlit LCD display, digit height 52 mm
- Overall dimensions W×D×H
 - A** 1600×1200×80 mm
 - B** 1800×1400×80 mm
- Platform height in the drive-through area: 80 mm
- Dimensions weighing surface
 - A** W×D 1000×1000 mm
 - B** W×D 1200×1200 mm
- Dimensions of display device W×D×H 250×160×65 mm
- Cable length of display device approx. 5 m
- Permissible ambient temperature -10 °C/40 °C

Accessories

- Protective working cover, scope of delivery: 5 items, KERN KFB-A02S05, **€ 40,-**
- **3** Stand to elevate display device, height of stand approx. 800 mm, Stand to elevate display device, height of stand approx. 800 mm, KERN BFS-A07, **€ 120,-**

- Pair of base plates to fix the weighing bridge to the floor, KERN BFS-A06, **€ 70,-**
- **Rechargeable battery pack internal**, operating time up to 35 h without backlight, charging time approx. 10 h, KERN KFB-A01, **€ 35,-**
- Bluetooth data interface for wireless data transfer to PC or tablets, must be ordered at purchase, not in combination with verification, KERN KFB-A03, **€ 130,-**
- Analogue module, must be ordered at purchase, not possible in combination with signal lamp 0-10 V: KERN KFB-A04, **€ 95,-**
4-20 mA: KERN KFB-A05, **€ 95,-**
- **4 Signal lamp** for visual support of weighing with tolerance range, KERN CFS-A03, **€ 250,-**
- **5 Large display with superior display size**, KERN YKD-A02, **€ 220,-**
- Y-cable for parallel connection of two terminal devices to the RS-232 interface on the scale, e.g. signal lamp and printer, KERN CFS-A04, **€ 35,-**
- Cable with special length 15 m, between display device and platform, for verified models which must be ordered at the time of purchase, KERN BFB-A03, **€ 160,-**
- Further details, plenty of further accessories and suitable printers see Accessories

Note: For verified scales the weighing bridge must be fixed to the floor. Optionally, with an access ramp, a footplate pair or a pit frame

1 Shipment via freight forwarder. Please ask for dimensions, gross weight, shipping costs

STANDARD



OPTION



FACTORY



Model	Weighing capacity [Max] kg	Readability = Verification value [d] = [e] kg	Minimal load [Min] kg	Net weight approx. kg	Weighing plate	Price excl. of VAT ex works €	Option			
							Verification		DAkKS Calibr. Certificate	
KERN								€	DAkKS KERN	€
NFB 600K200M	600	0,2	4	130	A	1450,-	965-230	132,-	963-130	165,-
NFB 600K200LM	600	0,2	4	165	B	1650,-	965-230	132,-	963-130	165,-
NFB 1.5T0.5M	1500	0,5	10	130	A	1350,-	965-230	132,-	963-130	165,-
NFB 1.5T0.5LM	1500	0,5	10	155	B	1650,-	965-230	132,-	963-130	165,-

Note: For applications that require verification, please order verification at the same time, initial verification at a later date is not possible. Verification at the factory, we need to know the full address of the location of use.

1 Price reduction



Stainless steel drive-through scale (IP68) with stainless steel display device (IP65), with EC type approval [M]

Features

- **Robust stainless steel drive-through scale** for rapid weighing of e.g. laundry carts, container trolleys, roller containers, etc. Ideal for hospital laundry services, goods inwards, hospital kitchens, etc.
- **Low platform height** and integrated access ramps on both sides facilitate access. No need for pit frame installation – which saves money
- **Ideal for the increased hygienic requirements** in the food, pharmaceutical and chemical industries
- **1 Weighing bridge:** stainless steel, extremely resistant to bending due to material thickness, 4 welded stainless steel load cells, dust and spray protection IP68. Weighing bridge can also be delivered as component without the display device, for details see KERN KFD-V40
- Your support in a **HACCP-compliant** quality system
- **2 Display device:** for details see KERN KFN-TM
- **Totalising** of weights and piece counts

- **Rechargeable battery pack internal** included with delivery
- **3 Did you know?** Our floor scales are delivered in a robust wooden box. This protects the high-quality weighing technology from environmental influences and stresses during transportation. KERN – always one step ahead

Technical data

- Large backlit LCD display, digit height 52 mm
- Overall dimensions WxDxH 1600x1200x80 mm
- Platform height in the drive-through area: 80 mm
- Dimensions weighing surface WxD 1000x1000 mm
- Dimensions of display device WxDxH 266x165x96 mm
- Cable length of display device approx. 5 m
- Permissible ambient temperature -10 °C/40 °C

Accessories

- **4 Stand** to elevate display device, height of stand approx. 800 mm, KERN BFN-A04, **€ 285,-**
- **Pair of base plates** to fix the weighing bridge to the floor, KERN BFN-A03, **€ 60,-**
- **Internal rechargeable battery pack**, operating time up to 35 h without backlight, charging time approx. 12 h, KERN GAB-A04, **€ 40,-**
- **Data interface RS-232**, interface cable included, approx. 1,5 m, must be ordered at purchase, KERN KFN-A01, **€ 95,-**
- **5 Large display with superior display size**, only in combination with data interface KFN-A1, KERN YKD-A02, **€ 220,-**
- **Cable with special length** 15 m, between display device and platform, for verified models which must be ordered at the time of purchase, KERN BFB-A03, **€ 160,-**
- Further details, plenty of further accessories and suitable printers see *Accessories*

Note: For verified scales the weighing bridge must be fixed to the floor. Optionally, with an access ramp, a footplate pair or a pit frame

1 Shipment via freight forwarder. Please ask for dimensions, gross weight, shipping costs

STANDARD

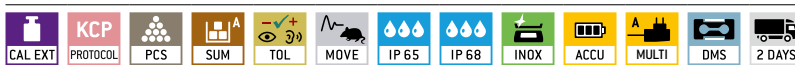

OPTION



FACTORY

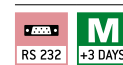

Model	Weighing capacity [Max] kg	Readability = Verification value [d] = [e] kg	Minimal load [Min] kg	Net weight approx. kg	Price excl. of VAT ex works €	Option			
						Verification		DAkkS Calibr. Certificate	
KERN							€	DAkkS KERN	€
NFN 600K-1M	600	0,2	4	130	2750,-	965-230	132,-	963-130	165,-
NFN 1.5T-4M	1500	0,5	10	125	2980,-	965-230	132,-	963-130	165,-

Note: For applications that require verification, please order verification at the same time, initial verification at a later date is not possible. Verification at the factory, we need to know the full address of the location of use.

Price reduction

KERN & SOHN GmbH
Balances, Test weights, Microscopes,
DAkkS calibration laboratory

Ziegelei 1
 72336 Balingen
 Germany

Tel. +49 7433 9933-0
 Fax +49 7433 9933-149

info@kern-sohn.com
 www.kern-sohn.com

Printed in Germany
 by KERN & SOHN GmbH
 z-ob-ge-kp-20201



1769

Ancestor Johann Jakob Sauter built the Hahn inclination scale out of iron, a foundation stone for weighing for the balance industry in Southern Germany

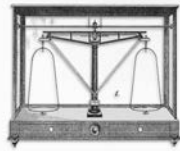

1844

KERN is founded – precision balances are produced



1863

A proud Gottlieb Kern with his staff



1880

Pharmaceutical balance with Aesculap



1923

Inflation – KERN wages are paid with self printed currency



1980

The electronic balance ousts mechanical devices



1994

Accredited DKD laboratory (ISO 17025)



2000

New premises in Balingen



2002

Existing QM system certification in accordance with DIN EN ISO 9001:2000 standards



2007

Approval for the manufacture of medical products (DIN EN 13485 and 93/42/EEC)



2008

Authorisation for initial verification by the manufacturer (2009/23/EC)



2009

Approval for the manufacture and sale of height rods (DIN EN 13485 and 93/42/EEC)



2012

Verification point for non-automatic balances and test weights.

New customer portal www.kern-sohn.com goes live



2014

Expansion of the product range to include optical instruments (microscopes and refractometers)



2015

Inauguration of Ziegelei 2.0 with computer-controlled high-bay warehouse



2017

Come with KERN into the digital future: Expansion of the model ranges compatible with Industry 4.0, as well as the related services



2019

Significant anniversary year! 25 years of accredited DKD laboratory 175 years of KERN & SOHN 250 years of balance manufacture in the Sauter family-owned company



2020

Construction of Ziegelei 3.0, extension of administration building